

DATOS TÉCNICOS DATASHEET

MARCA / BRAND : ELECTRO DH
CÓDIGO / CODE : 81.741/50

DESCRIPCIÓN: FOCO PARA EXTERIOR
DESCRIPTION: STREET LIGHT

ESPECIFICACIONES TÉCNICAS TECHNICAL SPECIFICATIONS



Tensión de entrada/ Input voltage:	85 ~ 265 VAC / 50 Hz
Potencia/ Power:	50W
Corriente nominal/ Rated current:	223 mA
Lúmenes/ Lumens:	5000 lm
Grado de protección/ Degree of protection:	IP65
Tipo de led/ Type of led:	SANAN CHIP
Temperatura de color/ Color temperature:	4000K
Ángulo de haz/ Beam angle:	120°
Vida útil/ Useful life:	20000 h
Factor de potencia PF/ Power factor:	>0.95
Índice de reproducción cromática/ Color rendering index:	>80
Medidas/ Measures:	410x128x50 mm

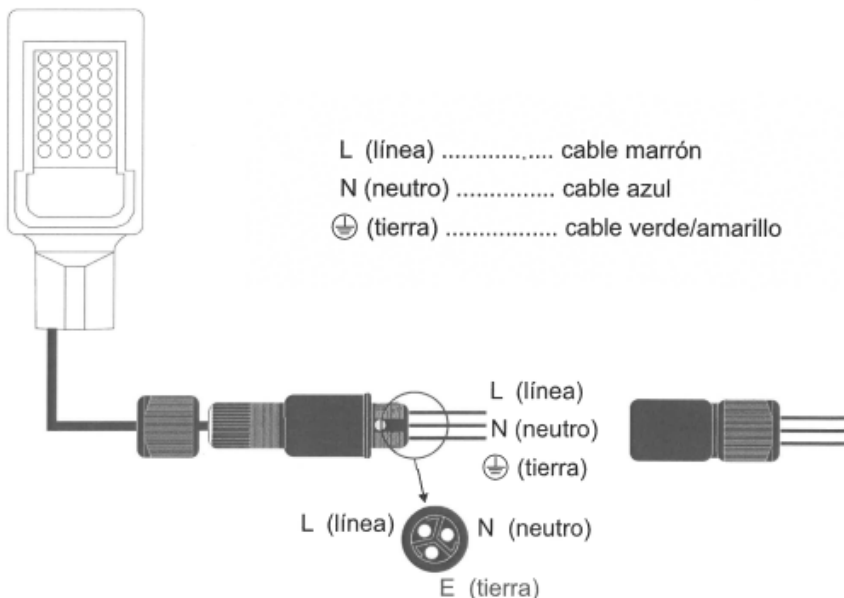

ELECTRO DH s.a.

Fortuna 29
08902 Hospitalet de LL (BCN)

